

**seppi m.®**

**MULCHING EQUIPMENT SPECIALISTS**

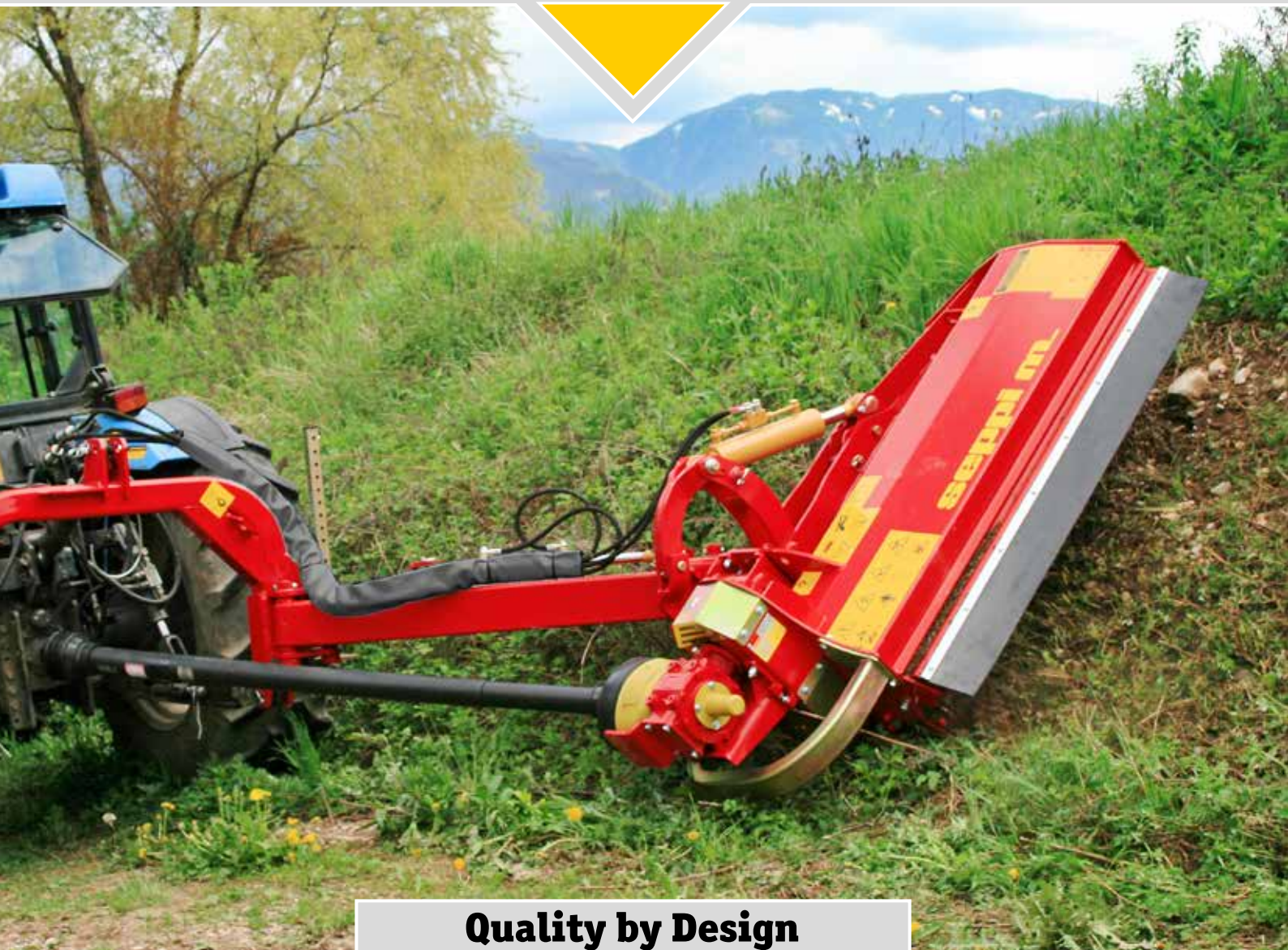

**Quality by Design**

## **OFFSETTING MULCHERS**

**SMWA avs - SMO avs - SAV**





**Discover the  
Advantages of  
seppi m.**<sup>®</sup>

### **INNOVATION**

- > over 75 years experience  
mulching equipment specialists since 1971
- > continuous research for new solutions and technologies
- > optimal material, with low wear

### **QUALITY**

- > every machine is tested before leaving the factory
- > use of the best components only
- > low wear

### **RELIABILITY**

- > high performance machines
- > close to customer sales and service network
- > fast and efficient customer care



“With offsetting mulchers by SEPPI M. I’m able to reach even such hard to reach areas as steep slopes and ditches. These mulchers are great because they’re easy to manoeuvre and at the same time they’re very solid. So I appreciate these mulchers as reliable partners for my work both as a farmer and as a contractor. I like to work with these machines!”

Mauro Pignatti - Modena, Italy  
farmer and contractor

### Offsetting mulchers by SEPPI M. :

- > For tractors from 40 to 150 HP.
- > Mulch grass, prunings and bushes up to 5, 7 and 12 cm [2", 2.8" and 4,7"] in diameter.
- > For greenspace maintenance along road sides, slopes, river banks and electricity lines. For agriculture, especially in steep vineyards and orchards.

### How to work with a SEPPI flail mower?

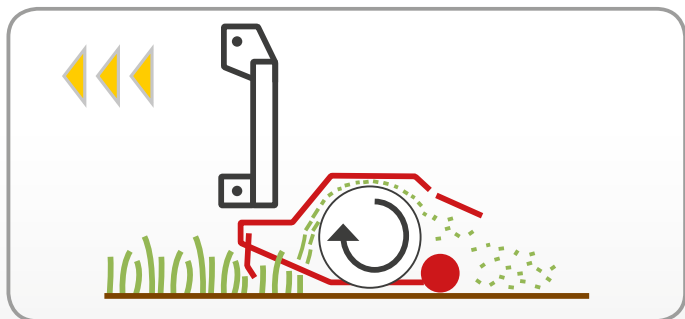

Open rear hood: to mulch grass with low power consumption

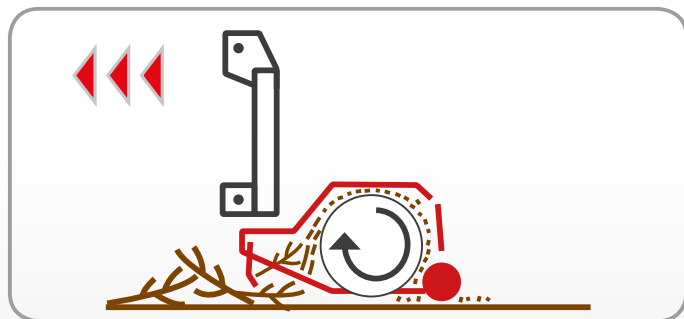

Closed rear hood: to finely mulch prunings and branches

### The SEPPI product range of offsetting mulchers:

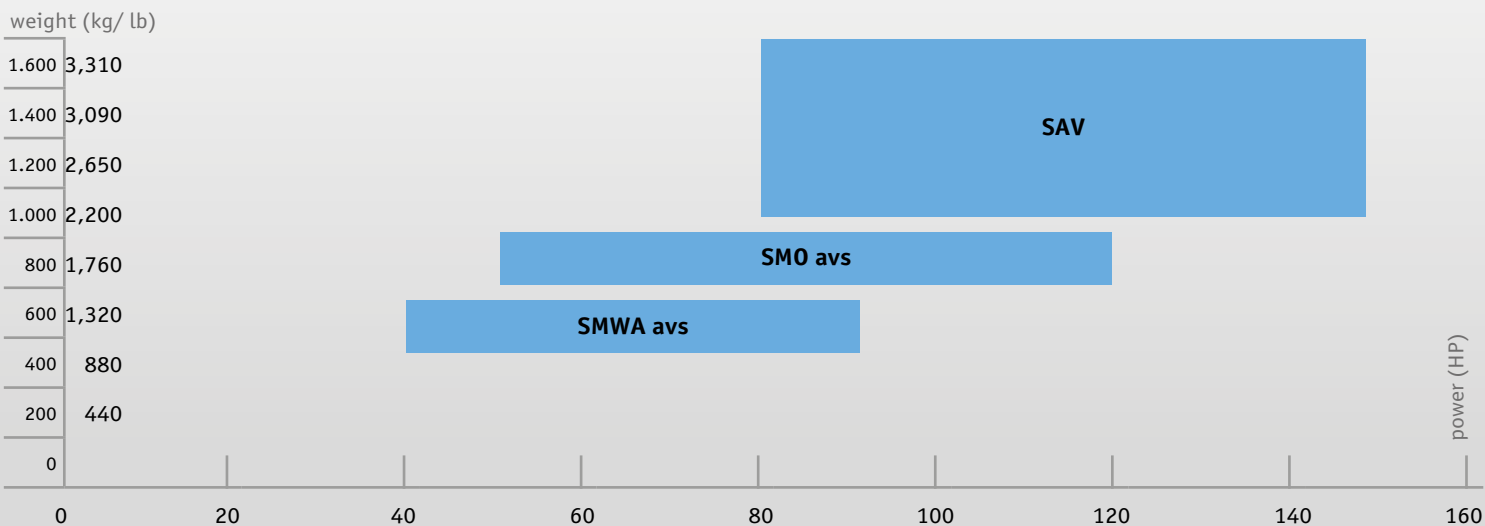

**On compact tractors: great versatility!**

features	SMO avs
mulches grass and brush up to	5 cm [2"] Ø
working speed	1 - 5 km/h
ISO 3-point linkage	≤ 125: cat.1&2, ≥ 155: cat. 2
side shift	hydraulic, to the right
positioning	hydraulic from +90° to -50°
gearbox with freewheel	540 rpm
input shaft	1 3/8" Z=6
number belts	≤ 155 cm: 3, ≥ 175 cm: 4
adjustable hood	with rubber flap
front protection	metal flaps or chains
support roller, adjustable in height	5 cm [2"]
required hydraulic service fittings	≤ 125: 2 double acting ≥ 155: 1 single & 1 double
standard rotor with flails	SMW

SMWA avs is an offsetting mulcher ideal for areas hard to reach such as ditches, slopes and river banks. But it also does a great mulching job on steep road sides, orchards and vineyards. Great versatility is achieved by ample side shift in addition to hydraulic angling from 90° up to 50° down.

OPT	options
058	PTO drive shaft with double wide angle
030	rotor with Y knives
414	attachment with safety breakaway FLEX-SAFE™
192	belt cover on the right
159	external transmission for 175+200
101	front attachment
269	lateral support rollers Ø 160 mm [6"]
006	additional rubber front protection
162	chevrons for public roads

**FLEX-SAFE™** (option)  
Safety breakaway to prevent breakages on linkage. Articulated attachment frame allows dynamic flexation.

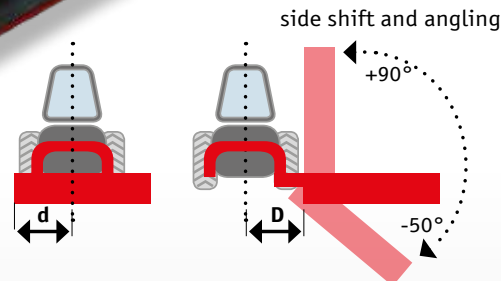
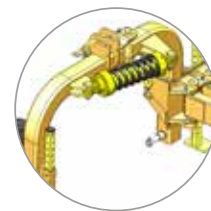

gearbox inside machine keeps the mower close to the tractor (appropriate e.g. for orchard rows)

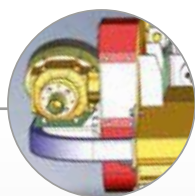

OPT 159 (175-200 cm): external gearbox allows large outrigging

SMWA avs	d	D
125	40 cm (16")	40 cm (16")
155-200	68 cm (27")	84 cm (33")
175-200 + OPT159	42 cm (17")	136 cm (54")

SMWA avs									
working width cm ["]	overall width cm ["]	depth cm ["]	height cm ["]	weight <sup>1</sup> kg [lb]	min. tractor weight <sup>2</sup> kg [lb]	flails standard #	Y knives OPT 030 #	roller Ø mm ["]	HP min-max
155 [61]	167 [66]	145 [57]	105 [41]	600 [1,320]	1.900 [4,190]	15	21	152 [6]	50-65
175 [69]	190 [75]	150 [59]	105 [41]	650 [1,430]	2.200 [4,850]	18	24	152 [6]	60-90
200 [79]	215 [85]	150 [59]	105 [41]	695 [1,530]	2.300 [5,070]	21	30	152 [6]	70-90

<sup>1</sup> The weight of the machine is approximate, it refers to the standard version without any options and it may vary.  
<sup>2</sup> The minimum tractor weight is approximate and depends on many factors, such as tractor wheel width and length. More information in the safety instructions.





**No matter what the situation:  
a strong mulcher in any position.**

features	SMO avs
mulches grass and brush up to working speed	7 cm [2,8"] Ø 1 - 5 km/h
ISO 3-point linkage	cat. 2
safety breakaway FLEX-SAFE™	standard
side shift	hydraulic, to the right
positioning	hydraulic from +90° to -50°
gearbox with freewheel	540 rpm
input shaft	1 3/8" Z=6
number belts	≤ 200 cm: 4, ≥ 225 cm: 5
adjustable hood	with rubber flap
front protection	metal flaps or chains
support roller, adjustable in height	5 cm [2"]
required hydraulic service fittings	2 double acting
standard rotor with flails	≤ 200: SMO, ≥ 225: SMW

**SMO avs** is a very strong offsetting mower. It mulches grass and brush up to 7 cm [2.8"] in diameter. Hydraulic angling and hydraulic side shift make it possible to work in many different positions and situations. It is suitable for the maintenance of greenspace such as slopes, road sides, or of steep orchards and vineyards. As on all the SEPPI flail mowers, it is possible to adjust the height of cut and the degree of mulching.

OPT	options
058	PTO drive shaft with double wide angle
030	rotor with Y knives
192	belt cover on the right
269	lateral support rollers Ø 160 mm [6"]
006	additional rubber front protection
162	chevrons for public roads

side shift and angling

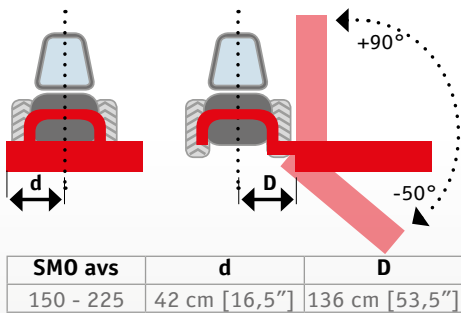

**FLEX-SAFE™** (standard)  
Safety breakaway to prevent breakages on linkage. Articulated attachment frame allows dynamic flexation.

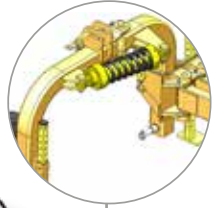

external gearbox for large outrigging

double linkage for special positioning



floating mechanism to follow the contours of the ground

SMO avs									
working width cm ["]	overall width cm ["]	depth cm ["]	height cm ["]	weight <sup>1</sup> kg [lb]	min. tractor weight <sup>2</sup> kg [lb]	flails standard #	Y knives OPT 030 #	roller Ø mm ["]	HP min-max
175 [69]	220 [87]	180 [71]	110 [43]	810 [1,790]	4.000 [8,820]	18	24	152 [6]	60-120
200 [79]	245 [96]	180 [71]	110 [43]	860 [1,900]	4.500 [9,920]	21	30	152 [6]	70-120
225 [89]	270 [106]	180 [71]	110 [43]	940 [2,070]	5.200 [11,465]	24	33	152 [6]	80-120

<sup>1</sup> The weight of the machine is approximate, it refers to the standard version without any options and it may vary.  
<sup>2</sup> The minimum tractor weight is approximate and depends on many factors, such as tractor wheel width and length. More information in the safety instructions.



## Perfect mulching on ditches and large areas.

features	SAV	
mulches grass and bushes up to	7 cm [2,8"] / 12 cm [4,7"] Ø	
working speed	3 - 7 km/h	
ISO 3-point linkage	cat. 2 rear	
side shift	hydraulic	
positioning	hydraulic from +90° to -65°	
gearbox with freewheel	up to 200 cm	540 rpm
	from 225 cm	1000 rpm
input shaft	1 3/8" Z=6	
transmission	multiband (6 belts) "Power-Belt"	
belt cover	with chevron for working & transportation on public street	
front protection	chains	
rear protection	rubber flap	
adjustable support roller	on hitch and mulcher	
breakaway device	standard	
required hydraulic service fittings	2 double acting	
standard rotor	SMO flails	

**SAV is a professional side mulcher for ditches, canals and river banks. It is equipped with hydraulic side shift and ample angle adjustments, and it mulches grass and brush up to 7 cm Ø [2.8"], or up to 12 cm [4.7"], if equipped with forestry rotor. Rear flap with direct discharge.**

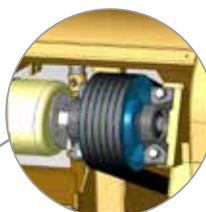

belt transmission with spring tension and safety coupling

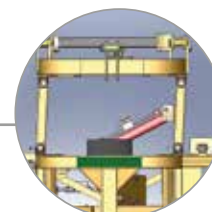

3-point linkage with parallel-linkage side shift

the cover with easy access to the drive system provides extra protection, and keeps out dirt

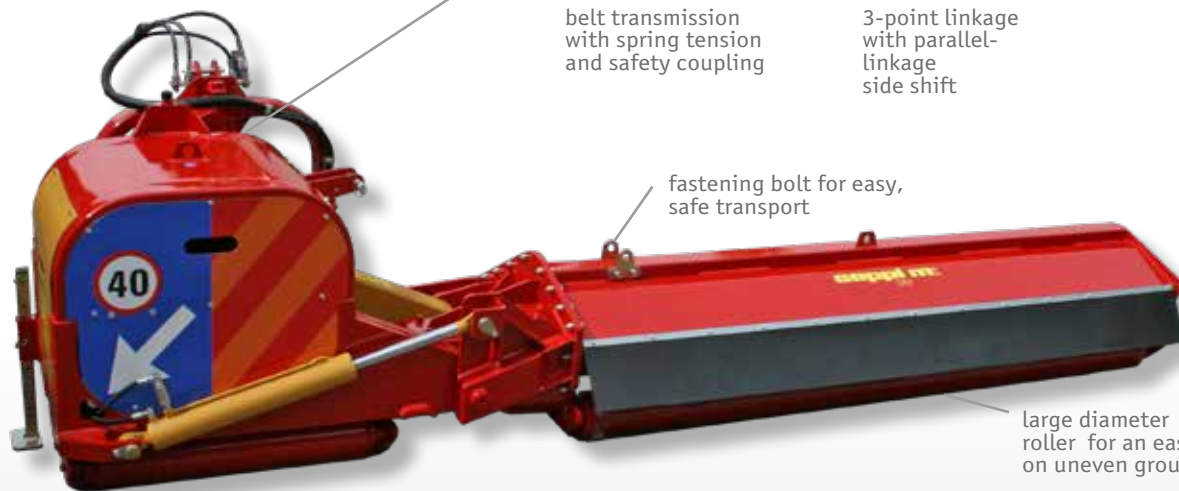

fastening bolt for easy, safe transport

large diameter of the roller for an easy work on uneven ground

SAV									
working width cm ["]	overall width cm ["]	depth cm ["]	height cm ["]	weight <sup>1</sup> kg [lb]	min. tractor weight <sup>2</sup> kg [lb]	flails standard #	Y knives OPT 030 #	roller Ø mm ["]	HP min-max
175 [69]	160-345 [63-136]	140 [55]	85-235 [33-93]	1.145 [2,524]	4.200 [9,300]	18	24	152 [6.0]	80-150
200 [79]	160-370 [63-146]	140 [55]	85-260 [33-102]	1.215 [2,679]	4.700 [10,400]	21	30	152 [6.0]	80-150
225 [89]	170-400 [67-157]	150 [59]	100-285 [39-112]	1.345 [2,965]	5.400 [11,900]	24	33	168 [6.6]	100-150
250 [98]	170-425 [67-167]	150 [59]	100-310 [39-122]	1.415 [3,120]	5.900 [13,000]	27	36	168 [6.6]	100-150
275 [108]	170-450 [67-177]	150 [59]	100-335 [39-132]	1.485 [3,274]	6.400 [14,100]	27	42	168 [6.6]	100-150

<sup>1</sup> The weight of the machine is approximate, it refers to the standard version without any options and it may vary.  
<sup>2</sup> The minimum tractor weight is approximate and depends on many factors, such as tractor wheel width and length. More information in the safety instructions.



**SAV: side shift and angling**

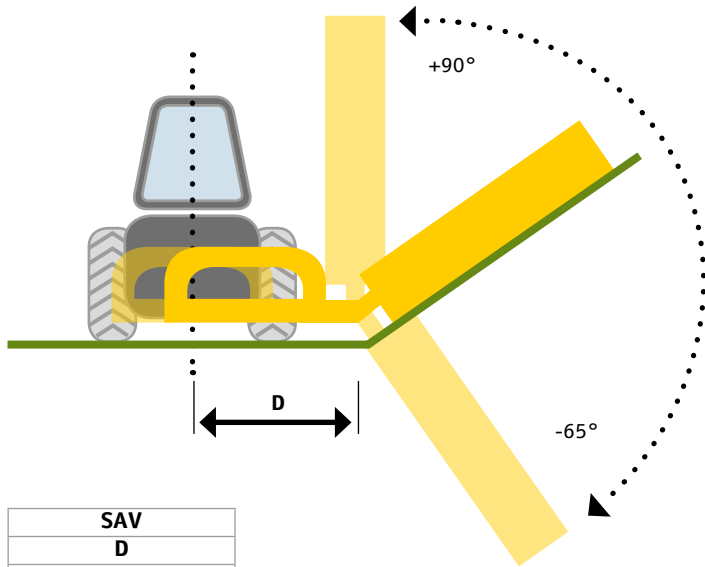

<b>SAV</b>
<b>D</b>
84 - 152 cm [33-60"]

The offsetting mulcher **SAV** comes with hydraulic angling from 90° up, to 65° down. According to the working width, the mulcher reaches a maximum position of 402 cm [158"] to the right.

<b>SAV options</b>	<b>OPT</b>
PTO with freewheel	011
rotor with 3 Y knives	030
swinging hammer forestry rotor (up to 200 cm)	240
fixed knife forestry rotor (up to 200 cm)	228
540 rpm gearbox	019
1000 rpm gearbox	018
accumulator to follow the contours of the ground	001
adjustable front hood	317
additional rubber safety protection	006
adjustable hood with rubber protection	087



All contents reserved. Specifications are subject to change without prior notice.

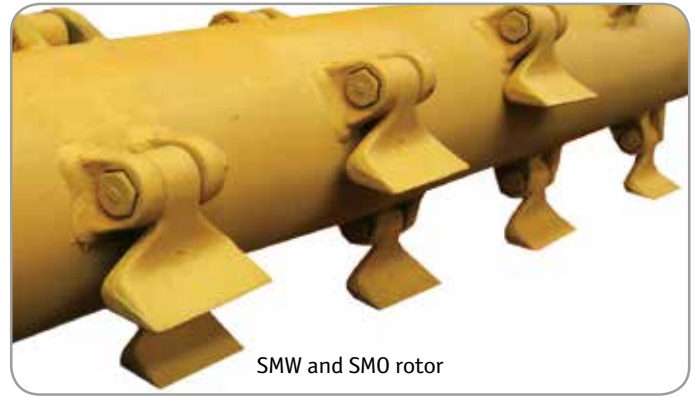

SMW and SMO rotor



SMW / SMO flails



Y knives  
OPT 030

SMW / SMO flails are standard  
Y knives are optional



forestry rotor  
swinging hammers



forestry rotor  
fixed knives MINI DUO



swinging hammers  
OPT 240



fixed knives  
OPT 228 "MINI DUO"

optional on **SAV**



## The Advantage of High Quality

### Mulching Equipment Pioneers

Founded in 1939 by Max Seppi, SEPPI M. is now one of the foremost manufacturer in its sector - not only in Europe, but worldwide. A pioneer like no other, SEPPI has been manufacturing mulching equipment for more than 45 years. SEPPI's mission is "To improve the professional's work through innovative and efficient solutions".

The many years of experience, together with the tireless research for more advanced technologies and more resistant materials result in the premium quality of the SEPPI equipment with tough machines that are reliable even under extreme working conditions.

The biggest gratification over the past 75 years has been our satisfied customers, who have benefitted from long and efficient work with the SEPPI equipment – a continuous motivation to keep on focusing on high quality! The family-based character of the company today being led by the third generation, stands for fair and responsible business relationships.

**Discover the many advantages of owning SEPPI equipment!**



### AGRICULTURAL, FORESTRY AND INDUSTRIAL MULCHERS

SEPPI M. S.p.A. - Zona Artigianale 1 - 39052 Caldaro (Bolzano) Italy  
Tel. +39 0471 963550 - Fax +39 0471 962547 - sales@seppi.it - www.seppi.com



### Türkiye Temsilcisi



**DEMPO**GROUP

Tel: 0332 351 0144

dempo@dempogroup.com

www.dempogroup.com